

**Specification:**

- 1.Low Loss IL:  $\leq 0.25\text{dB}$
- 2.Return Loss:  $\geq 65\text{dB}$
- 3.Operation Environment:  $-40\sim+85^{\circ}\text{C}$
- 4.Storage Environment:  $-40\sim+85^{\circ}\text{C}$

		<b>SHENZHEN OPTICO COMMUNICATION CO., LTD.</b>							
Model	SCAPC-SCAPC SM G657A2 Simplex 0.9mm Yellow LSZH CPR-Dca Cable					OP-1F-SCAPC-FP-0.9-SM-SX			
FIRST ANGLE PROJECTION 	MATERIAL	UNIT	SCALE	SIZE	SHEET	DRAWN	XUELING W	DATE	2025.04.29
	LSZH	m	/	A4	1	CHECKED	Michael Liu	DATE	2025.04.29
							APPROVED	STEVEN Zhang	DATE

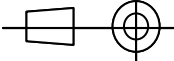
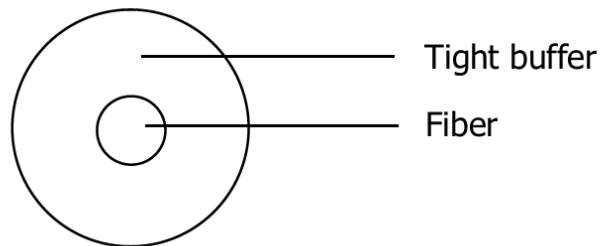
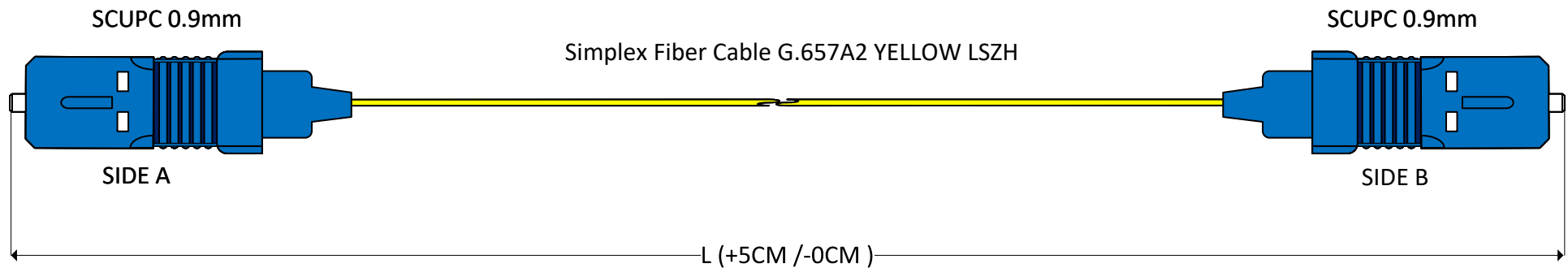

**Specification:**

- 1.Low Loss IL:  $\leq 0.25\text{dB}$
- 2.Return Loss:  $\geq 55\text{dB}$
- 3.Operation Environment:  $-40\sim+85^{\circ}\text{C}$
- 4.Storage Environment:  $-40\sim+85^{\circ}\text{C}$

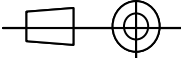
		<b>SHENZHEN OPTICO COMMUNICATION CO., LTD.</b>							
Model	SCUPC-SCUPC SM G657A2 Simplex 0.9mm Yellow LSZH CPR-Dca Cable						OP-1F-SCUPC-FP-0.9-SM-SX		
FIRST ANGLE PROJECTION 	MATERIAL	UNIT	SCALE	SIZE	SHEET	DRAWN	XUELING W	DATE	2025.04.29
	LSZH	m	/	A4	1	CHECKED	Michael Liu	DATE	2025.04.29
							APPROVED	STEVEN Zhang	DATE

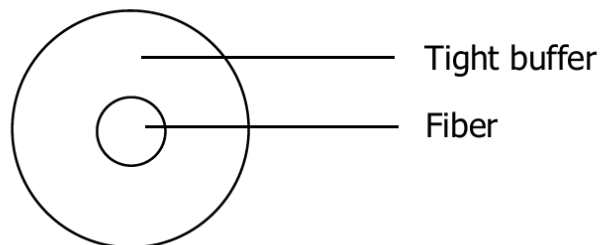
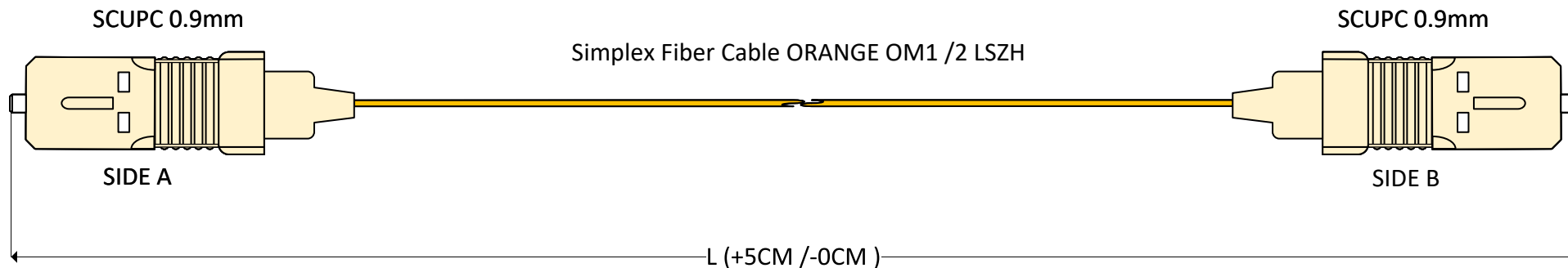

**Specification:**

- 1.Low Loss IL:  $\leq 0.25\text{dB}$
- 2.Return Loss:  $\geq 35\text{dB}$
- 3.Operation Environment:  $-40\sim+85^{\circ}\text{C}$
- 4.Storage Environment:  $-40\sim+85^{\circ}\text{C}$

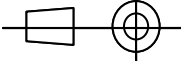
		<b>SHENZHEN OPTICO COMMUNICATION CO., LTD.</b>							
Model	SCUPC-SCUPC MM OM1 /2 Simplex 0.9mm ORANGE LSZH CPR-Dca Cable					OP-1F-SCUPC-FP-0.9-OM1 /2-MM-SX			
FIRST ANGLE PROJECTION 	MATERIAL	UNIT	SCALE	SIZE	SHEET	DRAWN	XUELING W	DATE	2025.04.29
	LSZH	m	/	A4	1	CHECKED	Michael Liu	DATE	2025.04.29
							APPROVED	STEVEN Zhang	DATE

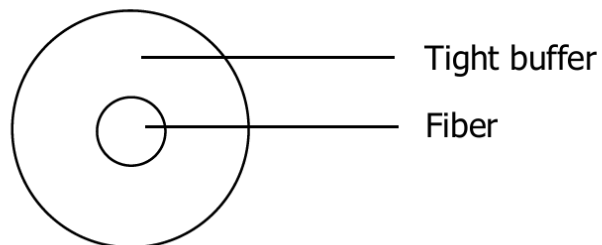
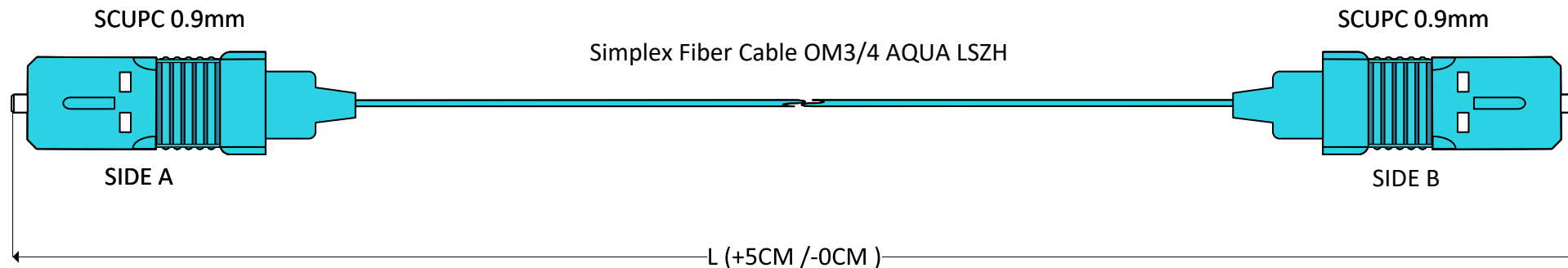

**Specification:**

- 1.Low Loss IL:  $\leq 0.25\text{dB}$
- 2.Return Loss:  $\geq 35\text{dB}$
- 3.Operation Environment:  $-40\sim+85^{\circ}\text{C}$
- 4.Storage Environment:  $-40\sim+85^{\circ}\text{C}$

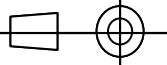
		<b>SHENZHEN OPTICO COMMUNICATION CO., LTD.</b>							
Model	SCUPC-SCUPC MM OM3 /4 Simplex 0.9mm Aqua LSZH CPR-Dca Cable					OP-1F-SCUPC-FP-0.9-OM3 /4-MM-SX			
FIRST ANGLE PROJECTION 	MATERIAL	UNIT	SCALE	SIZE	SHEET	DRAWN	XUELING W	DATE	2025.04.29
	LSZH	m	/	A4	1	CHECKED	Michael Liu	DATE	2025.04.29
							APPROVED	STEVEN Zhang	DATE

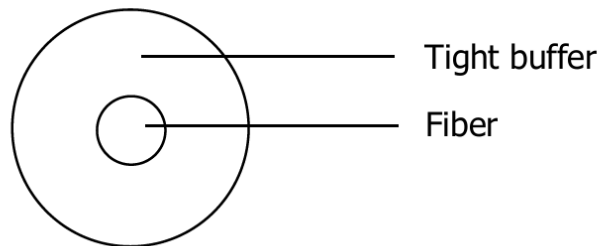
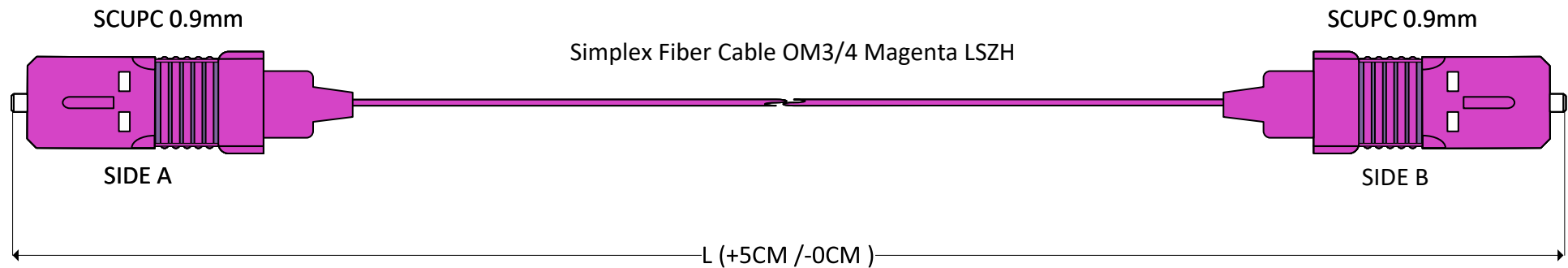

**Specification:**

- 1.Low Loss IL:  $\leq 0.25\text{dB}$
- 2.Return Loss:  $\geq 35\text{dB}$
- 3.Operation Environment:  $-40\sim+85^{\circ}\text{C}$
- 4.Storage Environment:  $-40\sim+85^{\circ}\text{C}$

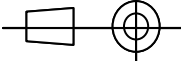
		<b>SHENZHEN OPTICO COMMUNICATION CO., LTD.</b>							
Model	SCUPC-SCUPC MM OM3 /4 Simplex 0.9mm Magenta LSZH CPR-Dca Cable					OP-1F-SCUPC-FP-0.9-OM3 /4-MM-SX			
FIRST ANGLE PROJECTION 	MATERIAL	UNIT	SCALE	SIZE	SHEET	DRAWN	XUELING W	DATE	2025.04.29
	LSZH	m	/	A4	1	CHECKED	Michael Liu	DATE	2025.04.29
							APPROVED	STEVEN Zhang	DATE

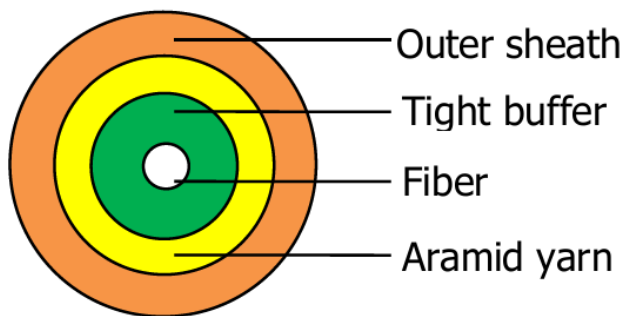

Structural Diagram

**Specification:**

- 1.Low Loss IL:  $\leq 0.25\text{dB}$
- 2.Return Loss:  $\geq 65\text{dB}$
- 3.Operation Environment:  $-40\sim+85^{\circ}\text{C}$
- 4.Storage Environment:  $-40\sim+85^{\circ}\text{C}$

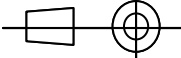
		<b>SHENZHEN OPTICO COMMUNICATION CO., LTD.</b>							
Model	SCAPC-SCAPC SM G657A2 Simplex 2.0/3.0mm Yellow LSZH CPR-Dca Cable						OP-1F-SCAPC-FP-2.0/3.0- SM-SX		
FIRST ANGLE PROJECTION 	MATERIAL	UNIT	SCALE	SIZE	SHEET	DRAWN	XUELING W	DATE	2025.04.29
	LSZH	m	/	A4	1	CHECKED	Michael Liu	DATE	2025.04.29
							APPROVED	STEVEN Zhang	DATE

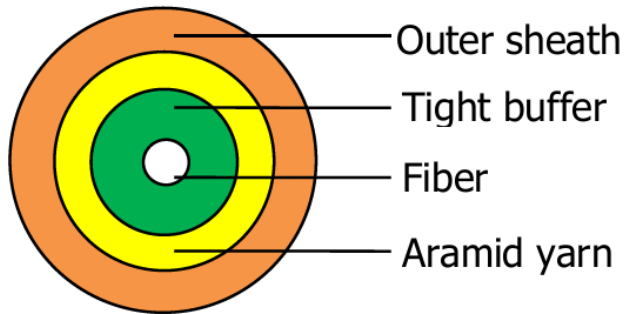
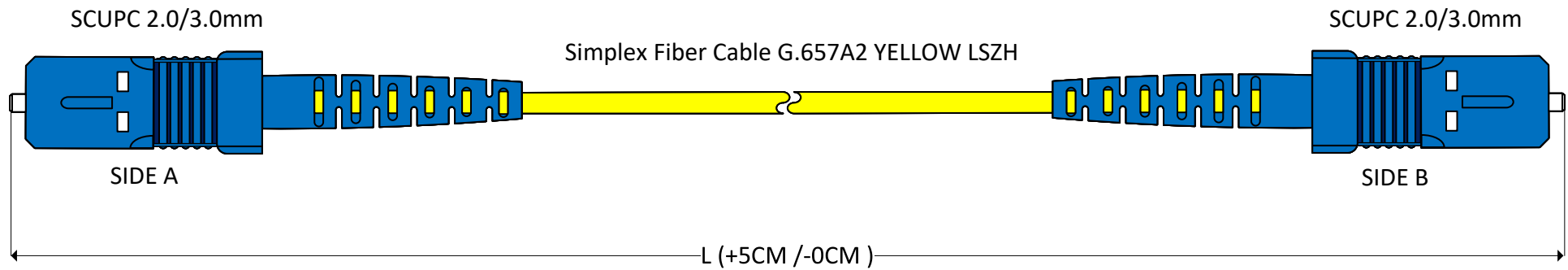

Structural Diagram

**Specification:**

- 1.Low Loss IL:  $\leq 0.25\text{dB}$
- 2.Return Loss:  $\geq 55\text{dB}$
- 3.Operation Environment:  $-40\sim+85^{\circ}\text{C}$
- 4.Storage Environment:  $-40\sim+85^{\circ}\text{C}$

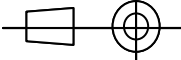
		<b>SHENZHEN OPTICO COMMUNICATION CO., LTD.</b>							
Model	SCUPC-SCUPC SM G657A2 Simplex 2.0/3.0mm Yellow LSZH CPR-Dca Cable					OP-1F-SCUPC-FP-2.0/3.0- SM-SX			
FIRST ANGLE PROJECTION 	MATERIAL	UNIT	SCALE	SIZE	SHEET	DRAWN	XUELING W	DATE	2025.04.29
	LSZH	m	/	A4	1	CHECKED	Michael Liu	DATE	2025.04.29
							APPROVED	STEVEN Zhang	DATE

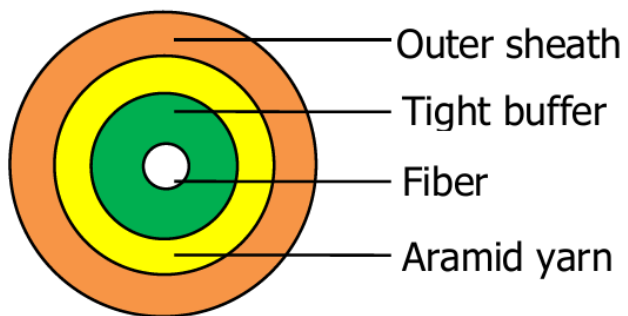
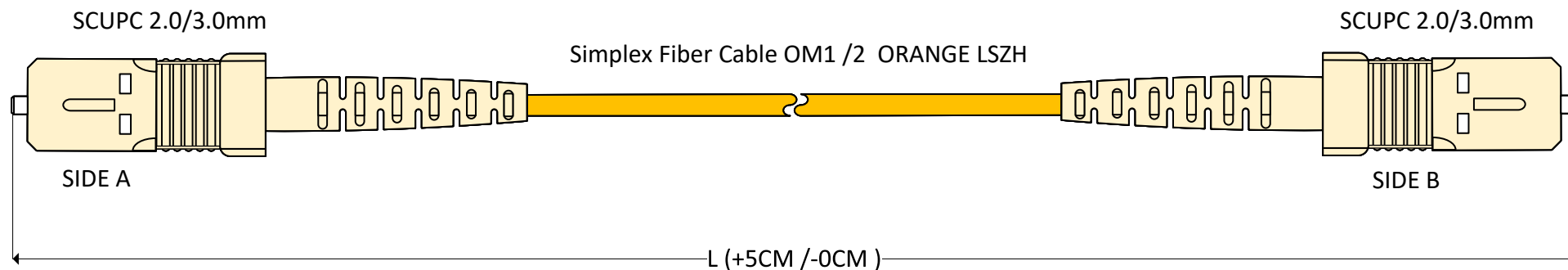

Structural Diagram

**Specification:**

- 1.Low Loss IL:  $\leq 0.25\text{dB}$
- 2.Return Loss:  $\geq 35\text{dB}$
- 3.Operation Environment:  $-40\sim+85^{\circ}\text{C}$
- 4.Storage Environment:  $-40\sim+85^{\circ}\text{C}$

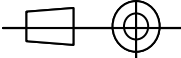
		<b>SHENZHEN OPTICO COMMUNICATION CO., LTD.</b>							
Model	SCUPC-SCUPC SM G657A2 Simplex 2.0/3.0mm Orange LSZH CPR-Dca Cable						OP-1F-SCUPC-FP-2.0/3.0-- MM-SX		
FIRST ANGLE PROJECTION 	MATERIAL	UNIT	SCALE	SIZE	SHEET	DRAWN	XUELING W	DATE	2025.04.29
	LSZH	m	/	A4	1	CHECKED	Michael Liu	DATE	2025.04.29
							APPROVED	STEVEN Zhang	DATE

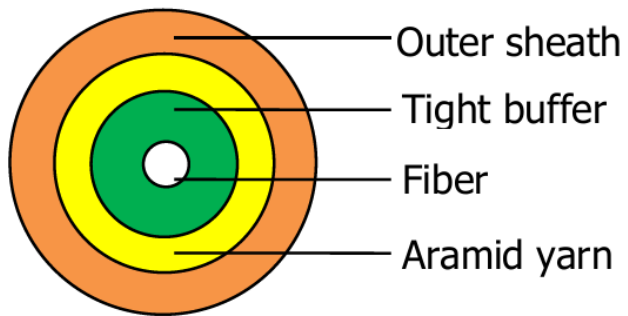
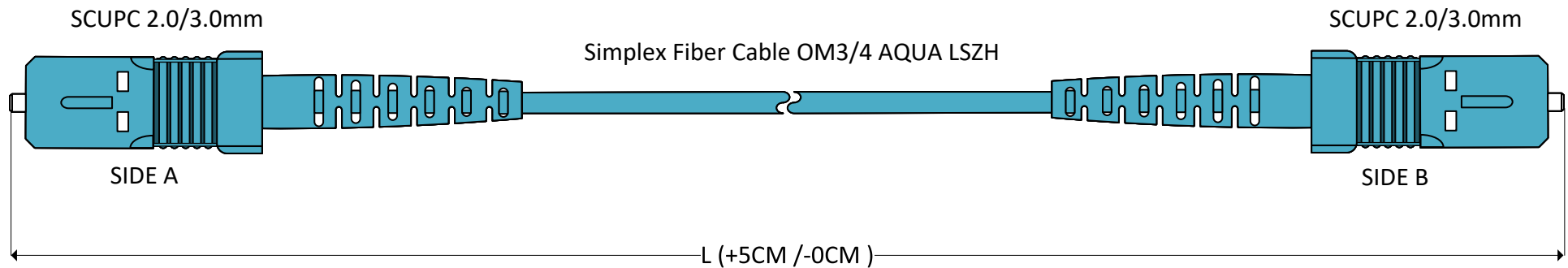

Structural Diagram

**Specification:**

- 1.Low Loss IL:  $\leq 0.25\text{dB}$
- 2.Return Loss:  $\geq 35\text{dB}$
- 3.Operation Environment:  $-40\sim+85^{\circ}\text{C}$
- 4.Storage Environment:  $-40\sim+85^{\circ}\text{C}$

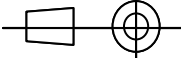
		<b>SHENZHEN OPTICO COMMUNICATION CO., LTD.</b>							
Model	SCUPC-SCUPC MM OM3/4 Simplex 2.0/3.0mm Aqua LSZH CPR-Dca Cable					OP-1F-SCUPC-FP-OM3 /4- MM-SX			
FIRST ANGLE PROJECTION 	MATERIAL	UNIT	SCALE	SIZE	SHEET	DRAWN	XUELING W	DATE	2025.04.29
	LSZH	m	/	A4	1	CHECKED	Michael Liu	DATE	2025.04.29
						APPROVED	STEVEN Zhang	DATE	2025.04.29

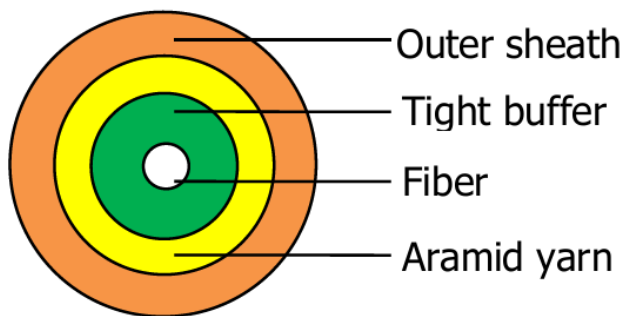
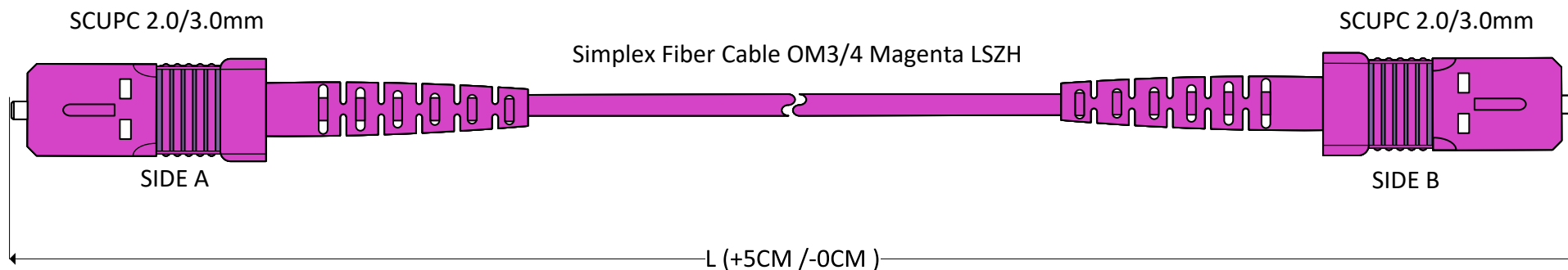

Structural Diagram

**Specification:**

- 1.Low Loss IL:  $\leq 0.25\text{dB}$
- 2.Return Loss:  $\geq 35\text{dB}$
- 3.Operation Environment:  $-40\sim+85^{\circ}\text{C}$
- 4.Storage Environment:  $-40\sim+85^{\circ}\text{C}$

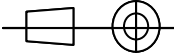
		<b>SHENZHEN OPTICO COMMUNICATION CO., LTD.</b>							
Model	SCUPC-SCUPC MM OM3/4 Simplex 2.0/3.0mm Magenta LSZH CPR-Dca Cable					OP-1F-SCUPC-FP-OM3 /4- MM-SX			
FIRST ANGLE PROJECTION 	MATERIAL	UNIT	SCALE	SIZE	SHEET	DRAWN	XUELING W	DATE	2025.04.29
	LSZH	m	/	A4	1	CHECKED	Michael Liu	DATE	2025.04.29
							APPROVED	STEVEN Zhang	DATE

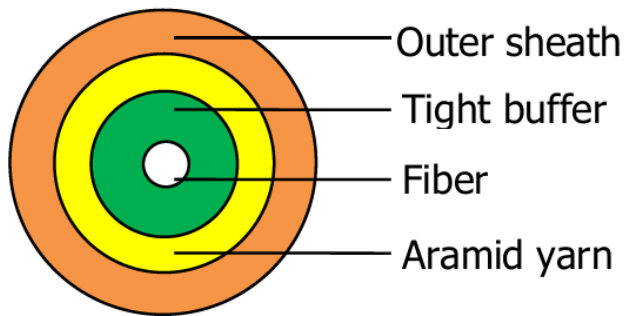
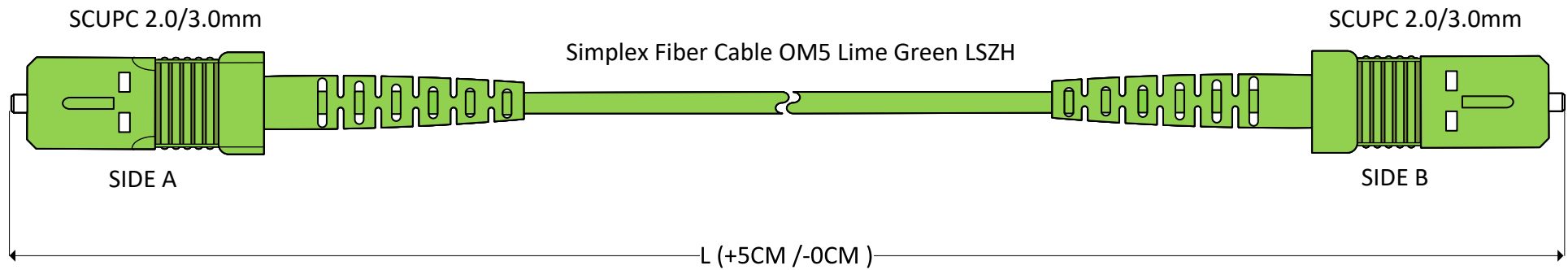

Structural Diagram

**Specification:**

- 1.Low Loss IL:  $\leq 0.25\text{dB}$
- 2.Return Loss:  $\geq 35\text{dB}$
- 3.Operation Environment:  $-40\sim+85^{\circ}\text{C}$
- 4.Storage Environment:  $-40\sim+85^{\circ}\text{C}$

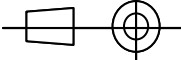
		<b>SHENZHEN OPTICO COMMUNICATION CO., LTD.</b>							
Model	SCUPC-SCUPC MM OM3/4 Simplex 2.0/3.0mm Lime Green LSZH CPR-Dca Cable					OP-1F-SCUPC-FP-OM5-MM-SX			
FIRST ANGLE PROJECTION 	MATERIAL	UNIT	SCALE	SIZE	SHEET	DRAWN	XUELING W	DATE	2025.04.29
	LSZH	m	/	A4	1	CHECKED	Michael Liu	DATE	2025.04.29
							APPROVED	STEVEN Zhang	DATE

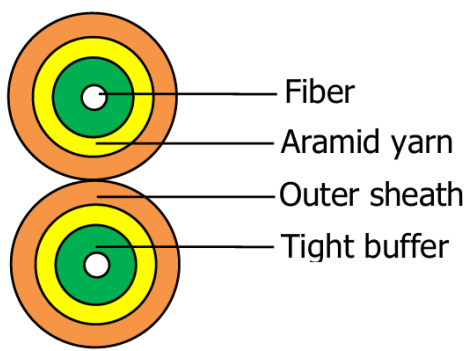
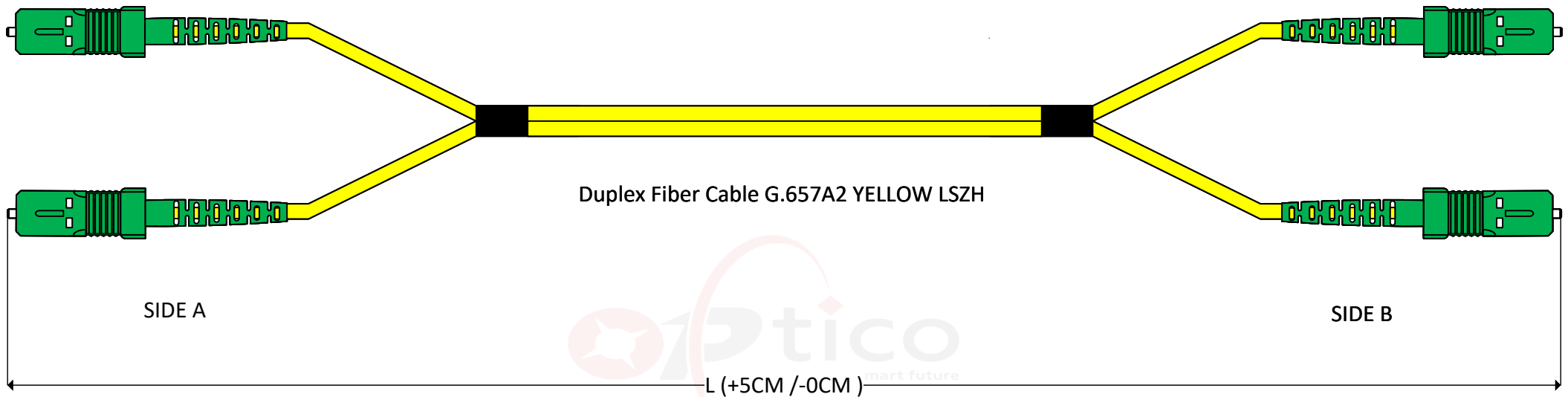

Structural Diagram

**Specification:**

- 1.Low Loss IL:  $\leq 0.25\text{dB}$
- 2.Return Loss:  $\geq 65\text{dB}$
- 3.Operation Environment:  $-40\sim+85^{\circ}\text{C}$
- 4.Storage Environment:  $-40\sim+85^{\circ}\text{C}$

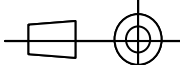
		SHENZHEN OPTICO COMMUNICATION CO., LTD.							
Model	SCAPC-SCAPC SM G657A2 Duplex 2.0/3.0mm Yellow LSZH CPR-Dca Cable					OP-2F-SCAPC-FP-2.0/3.0- SM-DX			
FIRST ANGLE PROJECTION 	MATERIAL	UNIT	SCALE	SIZE	SHEET	DRAWN	XUELING W	DATE	2025.04.29
	LSZH	m	/	A4	1	CHECKED	Michael Liu	DATE	2025.04.29
							APPROVED	STEVEN Zhang	DATE

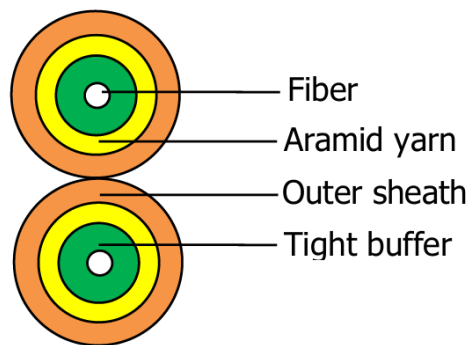
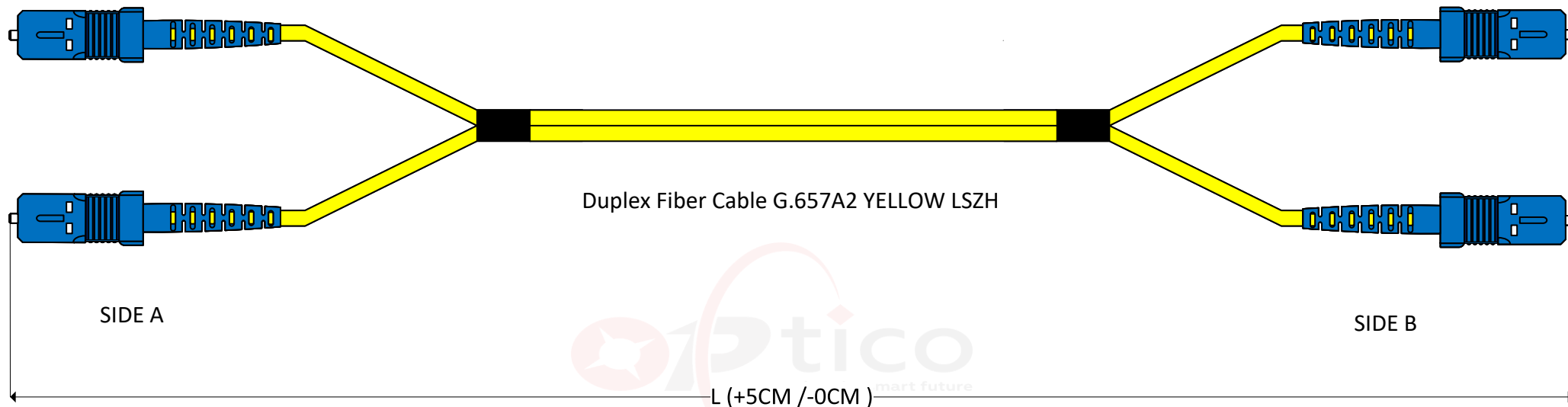

Structural Diagram

**Specification:**

- 1.Low Loss IL:  $\leq 0.25\text{dB}$
- 2.Return Loss:  $\geq 55\text{dB}$
- 3.Operation Environment:  $-40\sim+85^{\circ}\text{C}$
- 4.Storage Environment:  $-40\sim+85^{\circ}\text{C}$

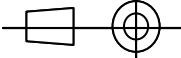
		<b>SHENZHEN OPTICO COMMUNICATION CO., LTD.</b>							
Model	SCUPC-SCUPC SM G657A2 Duplex 2.0/3.0mm Yellow LSZH CPR-Dca Cable					OP-2F-SCUPC-FP-2.0/3.0- SM-DX			
FIRST ANGLE PROJECTION 	MATERIAL	UNIT	SCALE	SIZE	SHEET	DRAWN	XUELING W	DATE	2025.04.29
	LSZH	m	/	A4	1	CHECKED	Michael Liu	DATE	2025.04.29
						APPROVED	STEVEN Zhang	DATE	2025.04.29

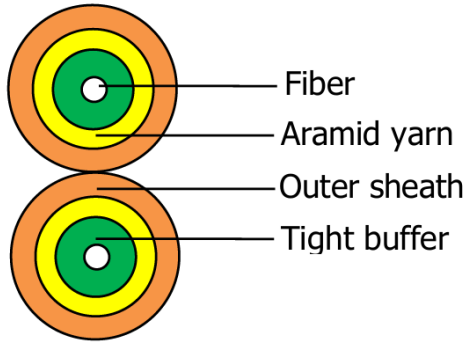
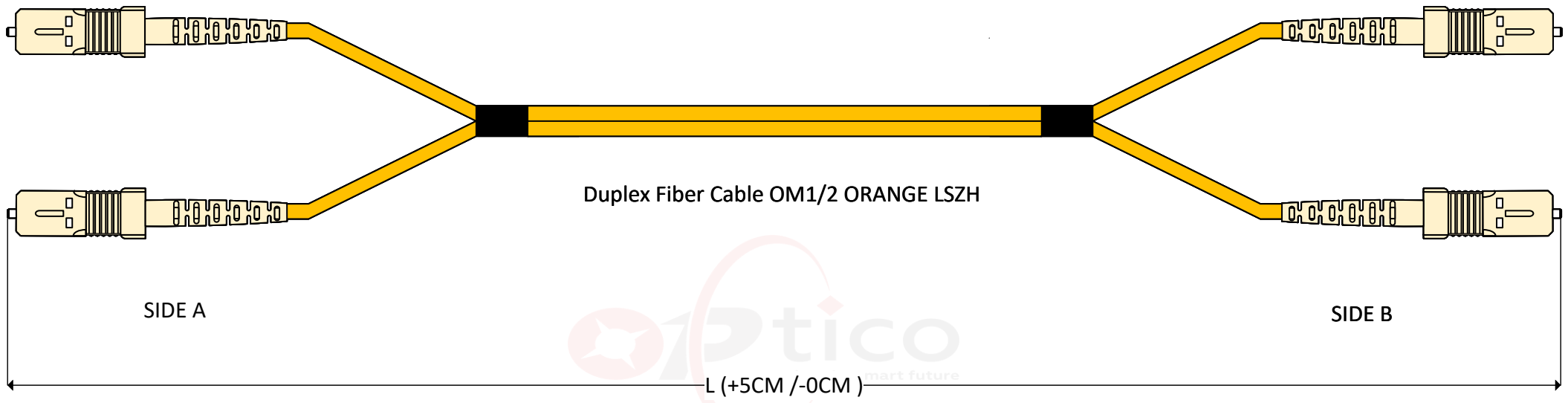

Structural Diagram

**Specification:**

- 1.Low Loss IL:  $\leq 0.25\text{dB}$
- 2.Return Loss:  $\geq 35\text{dB}$
- 3.Operation Environment:  $-40\sim+85^{\circ}\text{C}$
- 4.Storage Environment:  $-40\sim+85^{\circ}\text{C}$

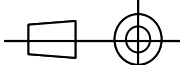
		SHENZHEN OPTICO COMMUNICATION CO., LTD.							
Model	SCUPC-SCUPC MM OM1/2 Duplex 2.0/3.0mm Orange LSZH CPR-Dca Cable					OP-2F-SCuPC-FP-2.0/3.0- MM-DX			
FIRST ANGLE PROJECTION 	MATERIAL	UNIT	SCALE	SIZE	SHEET	DRAWN	XUELING W	DATE	2025.04.29
	LSZH	m	/	A4	1	CHECKED	Michael Liu	DATE	2025.04.29
						APPROVED	STEVEN Zhang	DATE	2025.04.29

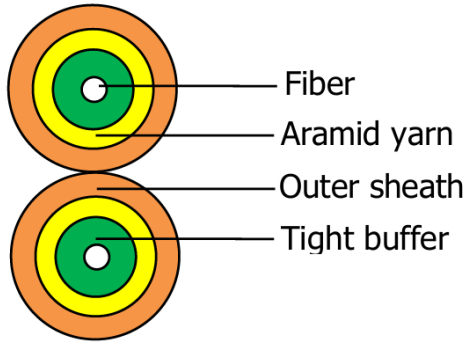
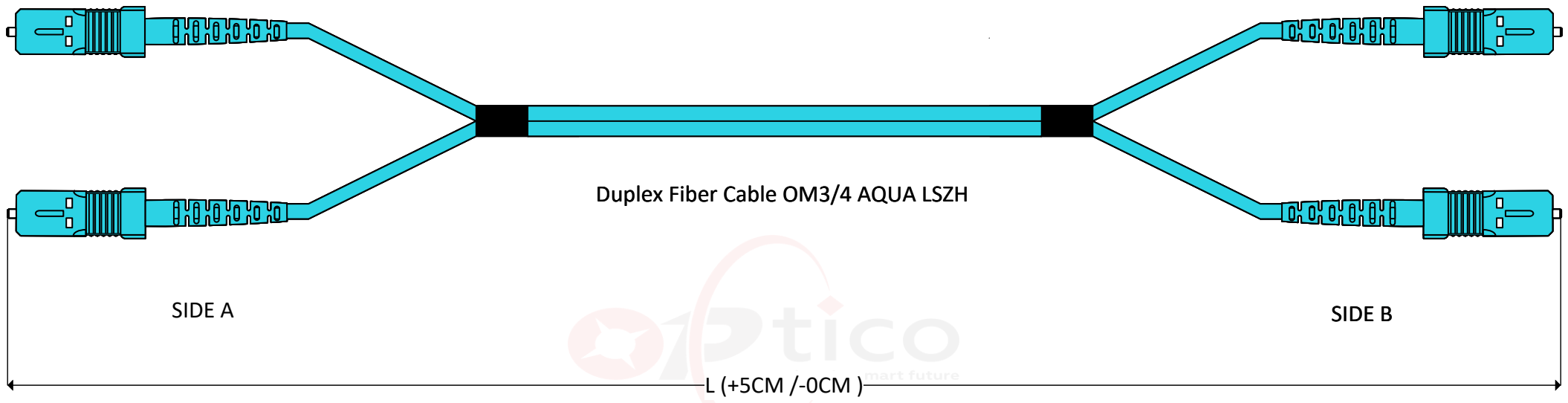

Structural Diagram

**Specification:**

- 1.Low Loss IL:  $\leq 0.25\text{dB}$
- 2.Return Loss:  $\geq 35\text{dB}$
- 3.Operation Environment:  $-40\sim+85^{\circ}\text{C}$
- 4.Storage Environment:  $-40\sim+85^{\circ}\text{C}$

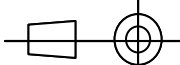
		<b>SHENZHEN OPTICO COMMUNICATION CO., LTD.</b>							
Model	SCUPC-SCUPC MM OM3/4 Duplex 2.0/3.0mm Aqua LSZH CPR-Dca Cable					OP-2F-SCUPC-FP-2.0/3.0- MM-DX			
FIRST ANGLE PROJECTION  	MATERIAL	UNIT	SCALE	SIZE	SHEET	DRAWN	XUELING W	DATE	2025.04.29
	LSZH	m	/	A4	1	CHECKED	Michael Liu	DATE	2025.04.29
							APPROVED	STEVEN Zhang	DATE

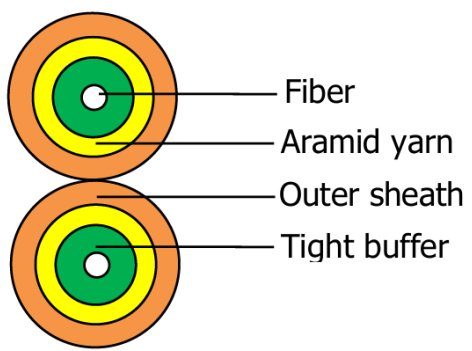
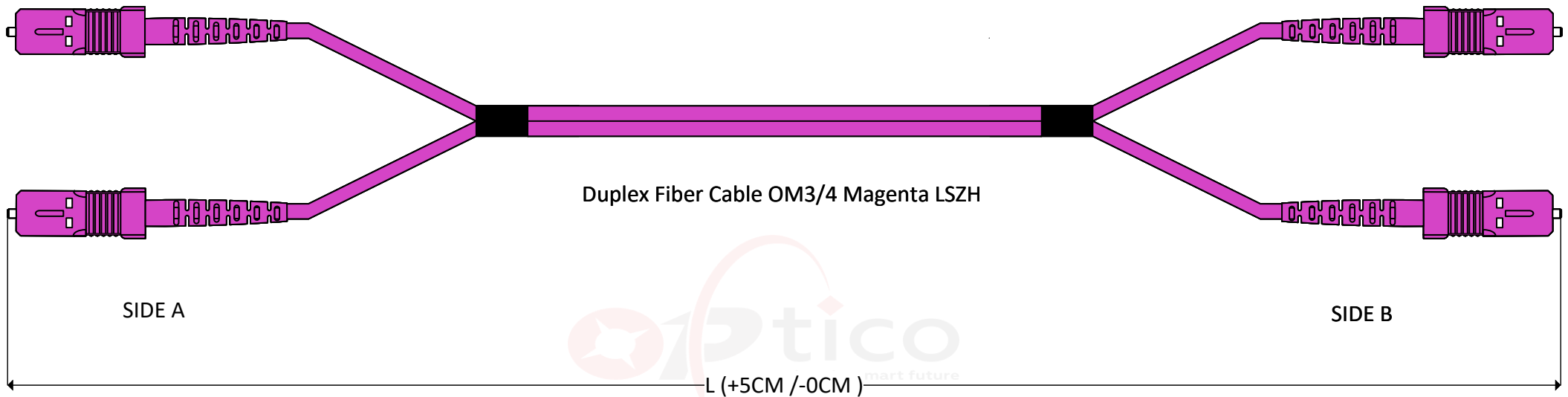

Structural Diagram

**Specification:**

- 1.Low Loss IL:  $\leq 0.25\text{dB}$
- 2.Return Loss:  $\geq 35\text{dB}$
- 3.Operation Environment:  $-40\sim+85^{\circ}\text{C}$
- 4.Storage Environment:  $-40\sim+85^{\circ}\text{C}$

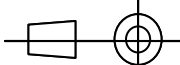
		<b>SHENZHEN OPTICO COMMUNICATION CO., LTD.</b>							
Model	SCUPC-SCUPC MM OM3/4 Duplex 2.0/3.0mm Magenta LSZH CPR-Dca Cable					OP-2F-SCUPC-FP-2.0/3.0- MM-DX			
FIRST ANGLE PROJECTION  	MATERIAL	UNIT	SCALE	SIZE	SHEET	DRAWN	XUELING W	DATE	2025.04.29
	LSZH	m	/	A4	1	CHECKED	Michael Liu	DATE	2025.04.29
							APPROVED	STEVEN Zhang	DATE

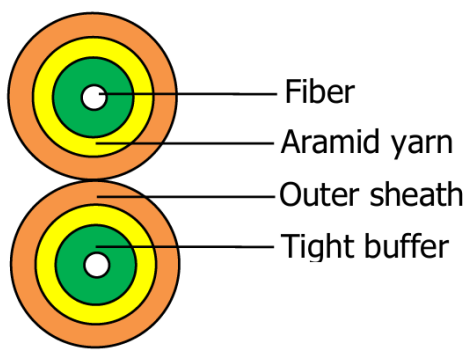
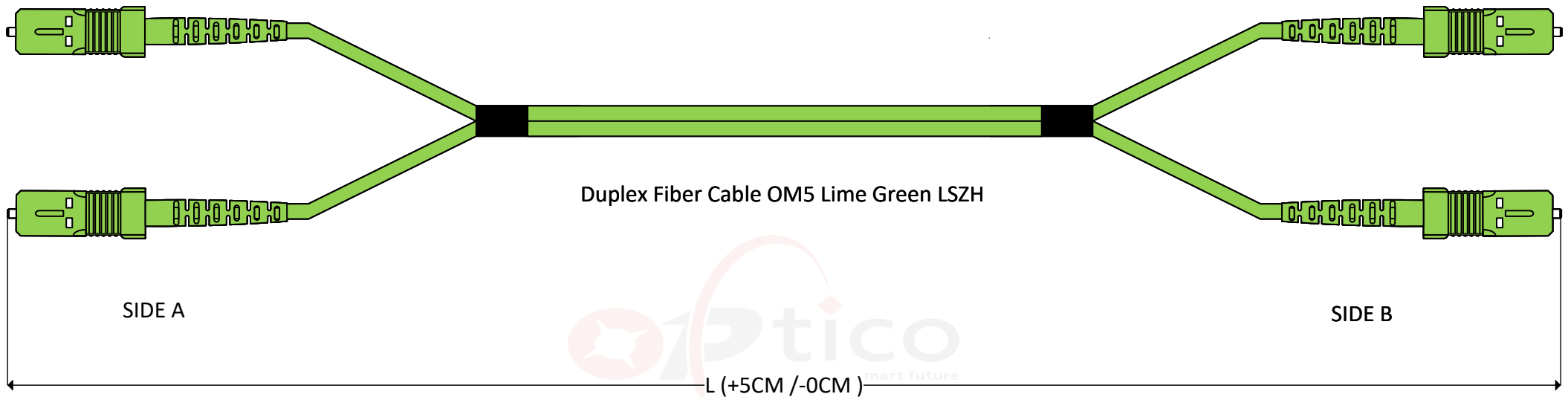

Structural Diagram

**Specification:**

- 1.Low Loss IL:  $\leq 0.25\text{dB}$
- 2.Return Loss:  $\geq 35\text{dB}$
- 3.Operation Environment:  $-40\sim+85^{\circ}\text{C}$
- 4.Storage Environment:  $-40\sim+85^{\circ}\text{C}$

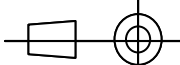
		<b>SHENZHEN OPTICO COMMUNICATION CO., LTD.</b>							
Model	SCUPC-SCUPC MM OM5 Duplex 2.0/3.0mm Lime Green LSZH CPR-Dca Cable					OP-2F-SCUPC-FP-2.0/3.0- MM-DX			
FIRST ANGLE PROJECTION  	MATERIAL	UNIT	SCALE	SIZE	SHEET	DRAWN	XUELING W	DATE	2025.04.29
	LSZH	m	/	A4	1	CHECKED	Michael Liu	DATE	2025.04.29
							APPROVED	STEVEN Zhang	DATE